

HL930A

WHEEL LOADER



Engine Power
99 kW

Bucket Capacity
1.9 m³

Operating Weight
11500 kg

READY TO CHANGE YOUR WORLD

The HL930 Wheel Loader is part of HD Hyundai's brand new A-series: a fresh generation of construction equipment that complies with the European Stage V emission levels. But it goes much further than that!

While fulfilling regulatory demands, HD Hyundai aimed for a ground-breaking level of customer satisfaction with maximum performance and productivity, better safety, more convenience and improved uptime management.

Featuring impressive power matched with carefully selected technologies that help you to work more efficiently and economically, this versatile loader opens up a world of new possibilities. It's time to experience the HD Hyundai Effect!

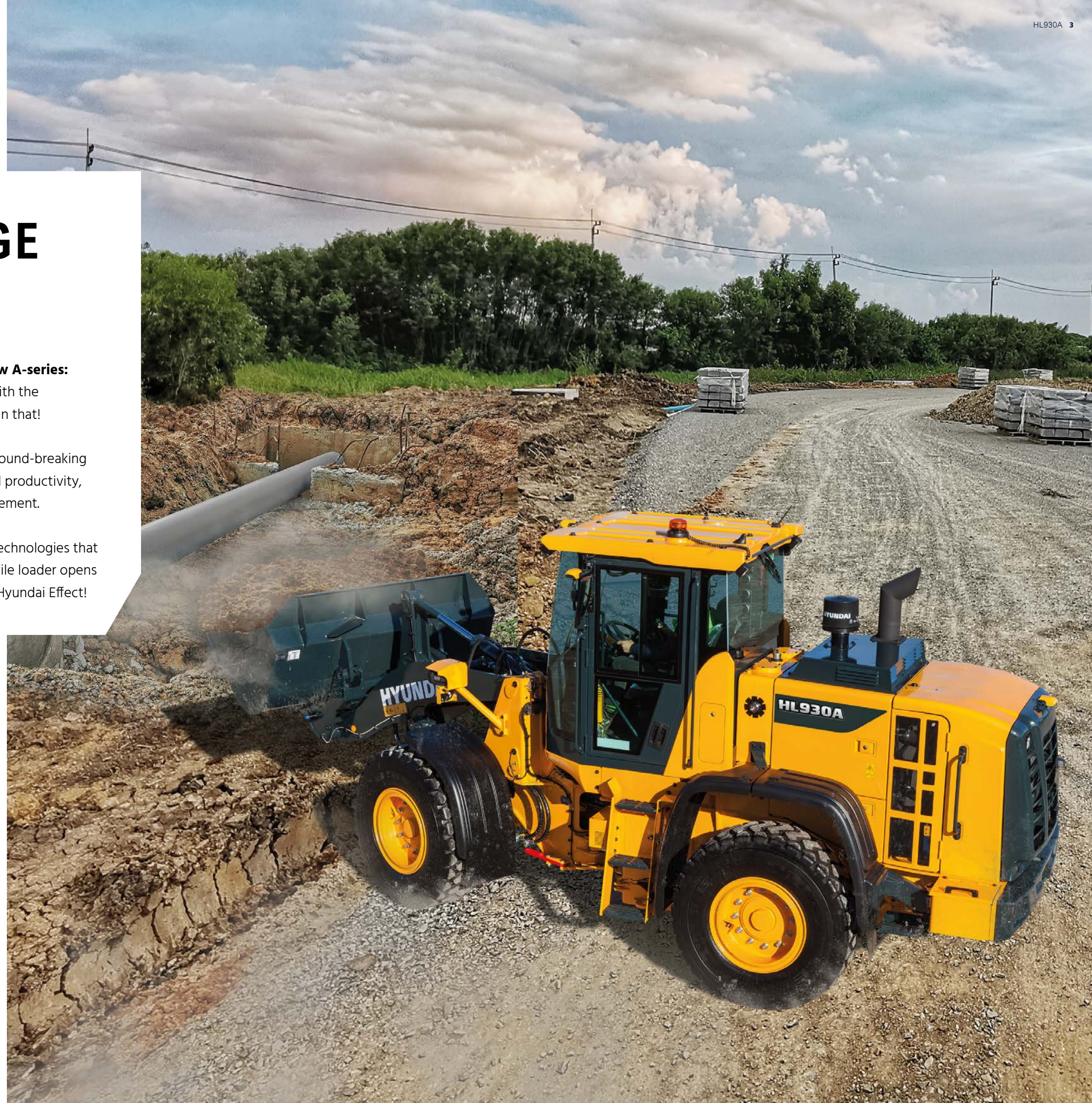

Productivity & Efficiency

TECHNOLOGIES DESIGNED TO BOOST YOUR PRODUCTIVITY

The HL930A is powered by a robust Stage V-certified engine designed to deliver maximum productivity and fuel savings while complying with the strict European Stage V emission requirements. Precise operating systems ensure you get the most out of the machine's impressive performance, including optimised power matching for the ultimate balance of torque and RPM. Additional control, monitoring and maintenance features help you to optimise efficiency and productivity every single day, on any worksite.

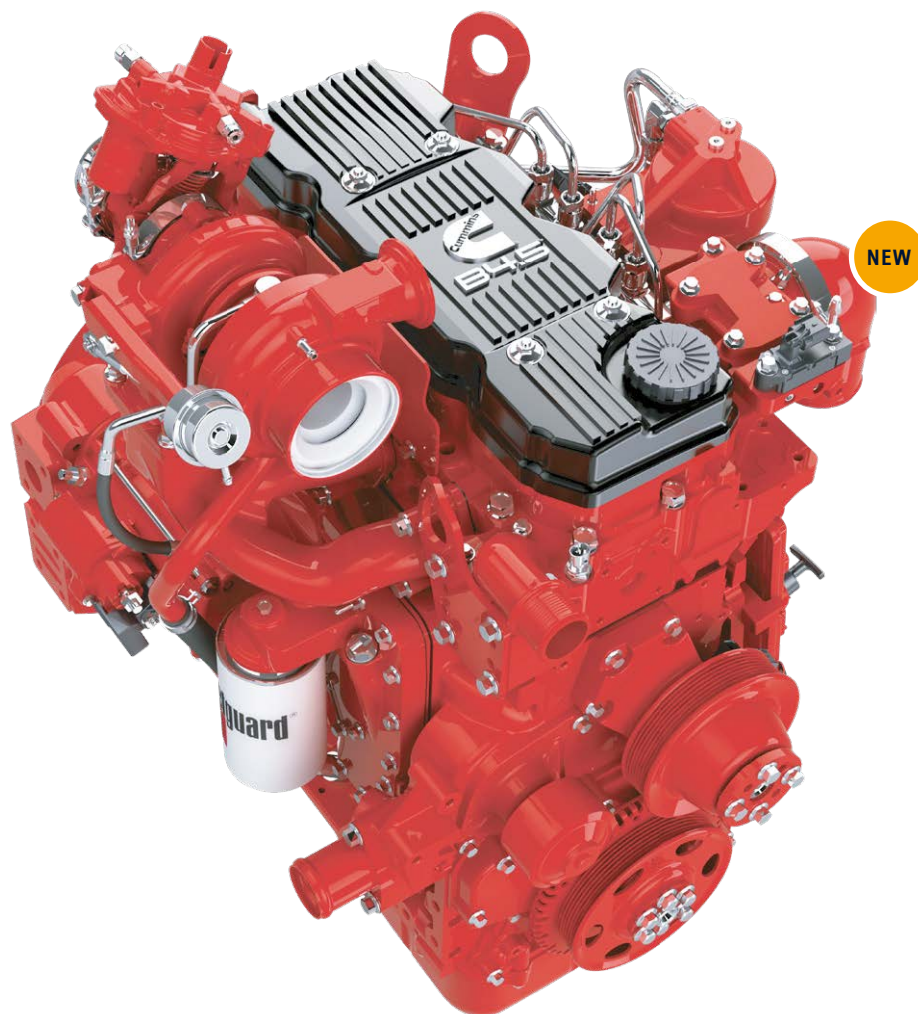

NEW

Engine
The reliable Cummins B4.5 Stage V engine delivers all the power you need to tackle heavy-duty work in extreme conditions. Like all A-Series machines, the HL930A features our all-in-one exhaust aftertreatment system which cuts emissions and operating costs. By removing the need for EGR, this system enhances reliability and simplifies maintenance.

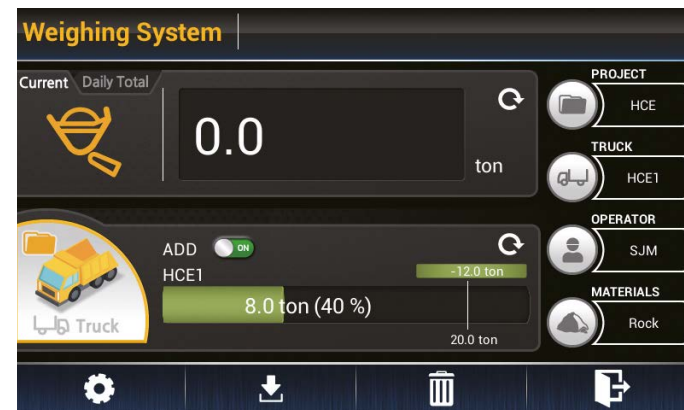
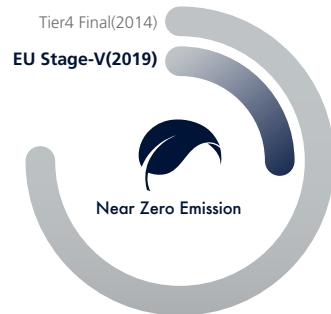

Weighing system
The highly accurate automatic/manual cumulative weighing system helps you to manage production more efficiently in any environment. For maximum precision and follow-up, a dedicated weighing screen can be displayed on the main monitor. The display includes weighing error icons for effective operator support.

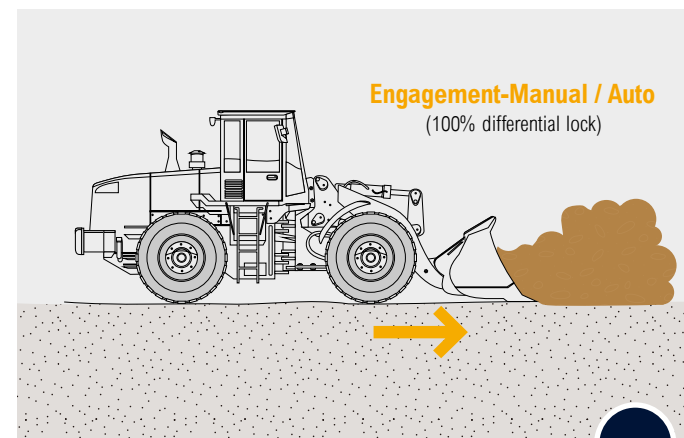

OPTION

Hydraulic differential lock
The optional hydraulic locking differential prevents tyre slip for more secure operation as well as better productivity and fuel economy.

Automatic engine shutdown
Adjustable to suit the operator's preference, this function shuts the engine down automatically when the machine is at rest to cut fuel consumption and prevent unnecessary emissions.

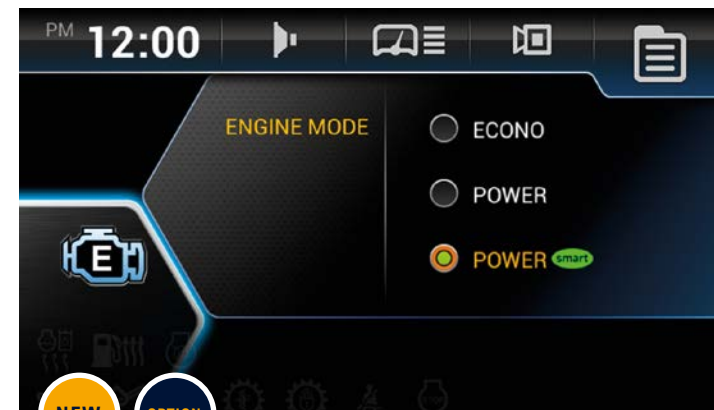
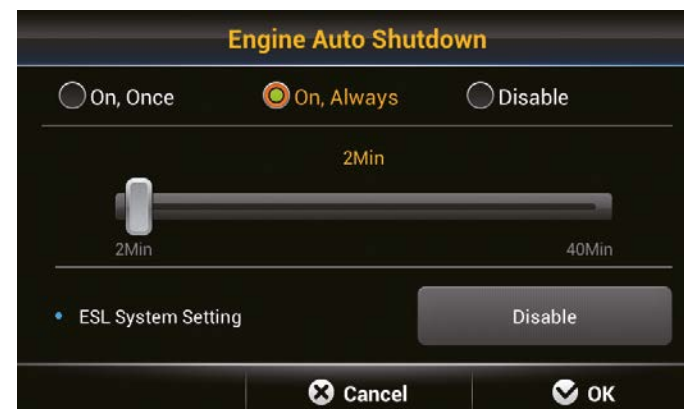

NEW

OPTION

Smart power mode
This optional working mode reduces fuel consumption by adjusting the engine speed in heavy load work like digging. This function has two key benefits: it not only saves fuel while offering the same performance as Power mode, but also achieves a good balance between traction force and breakout force.

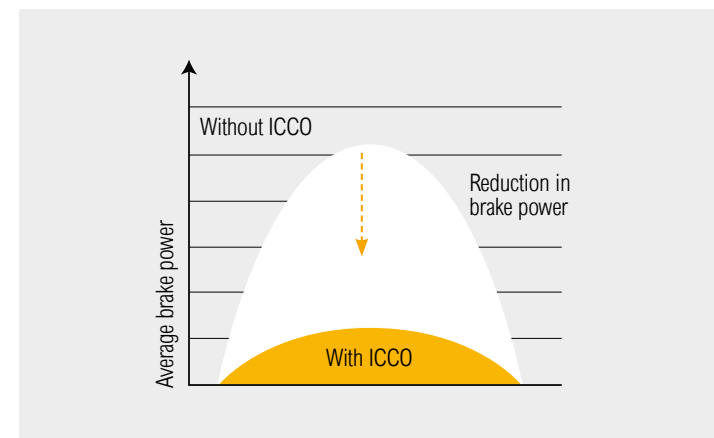

Intelligent Clutch Cut-Off (ICCO)
The ICCO function minimises loss of power in the torque converter and prevents excessive power use during braking. This reduces heat generation and wear on the brake disc.

Eco Report
The Eco Report feature makes it easy for operators to develop efficient working habits by displaying real-time information about machine performance.

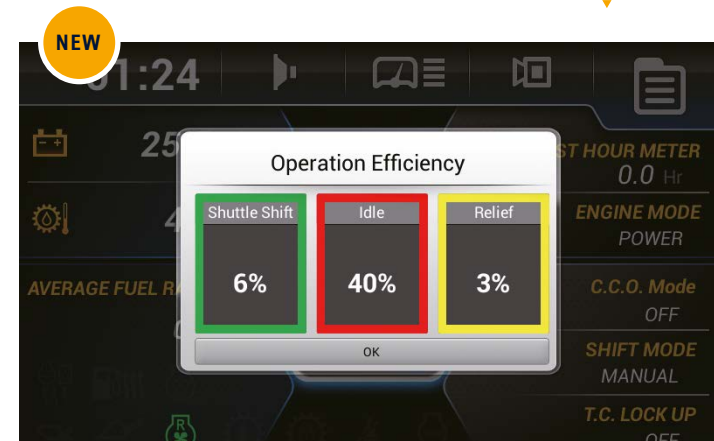

Durability

TOUGH AND DURABLE TO SAFEGUARD YOUR PROFITS

To protect your business, you need to know that the investment you make today will help sustain your profits over the long term. That's why we prioritised reliability throughout the development of the HL930A, from design and manufacturing to quality control.

All components and operating systems have been optimised for endurance and tested rigorously on a range of work sites. The result is a tough, dependable workhorse that minimises downtime for repairs and maintenance so you can stay on schedule and protect your reputation.



“Every part of the machine is built for rock-solid dependability, even when the going gets tough.”

Hydraulic hoses
High-grade hoses with outstanding resistance to heat and pressure provide maximum durability, even in rough working conditions.



Brake discs
The brake discs are manufactured using a durable sinter material to suppress the generation of heat and vibration. They extend the lifetime of the brakes, while also integrating a service-friendly design.



Aftertreatment system
Simple and durable fully integrated “all-in-one” aftertreatment system.



Premium quality axles
The HL930A features premium quality axles with enhanced load capacity for better reliability and durability.

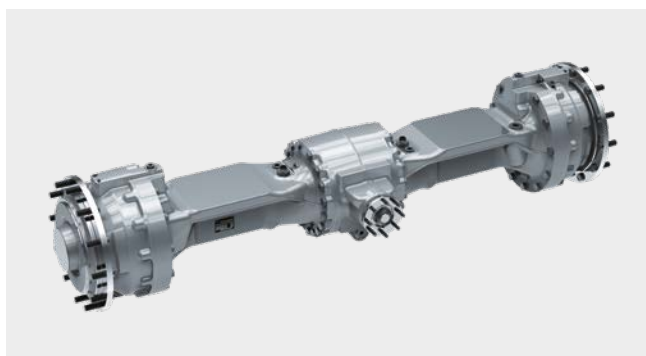

Operator Comfort

A CABIN DESIGNED AROUND YOU

The HL930A cabin was designed to be a productive, stress-free working environment that fits every operator perfectly. Comfortable and spacious, it features state-of-the-art noise and vibration reduction technology, achieving a sound level of only 70 dB, one of the lowest in this machine category. The high-quality, adjustable seat provides comfortable reach to all controls. A range of technologies enable easier machine monitoring, while the audio system includes a radio with a USB input to keep you entertained during your working day.



NEW

Adjustable seat and armrest

The HL930A has a large, comfortable seat with heating as standard. The seat and armrest are fully adjustable for added comfort.

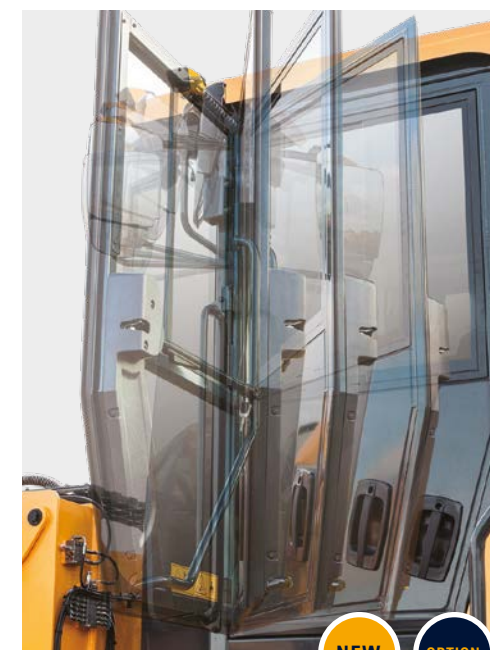

NEW

OPTION

Remote door control

As an option, the cabin door can be opened remotely for added convenience and safety.



NEW

OPTION

Air compressor

An optional air compressor can be mounted in the cabin to help operators keep their workspace pleasant and comfortable.

Ride control system

An optional ride control system with a piston accumulator reduces pitching of the wheel loader body and bucket for more stable and comfortable operation. It also minimises spillover, adding to convenience and productivity.

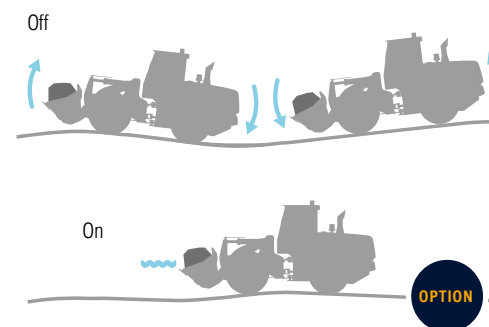

Touchscreen monitor

The instrument panel is optimised to provide quick, easy access to machine status information as you work. It features a seven-inch touchscreen monitor for excellent legibility. You can connect your Android™ mobile device through Miracast™.



Soft end stop

The optional soft end stop function reduces the hydraulic speed of the cylinder as it reaches the end of its stroke. This lessens the shock load of the stroke for increased operating comfort and better material retention.

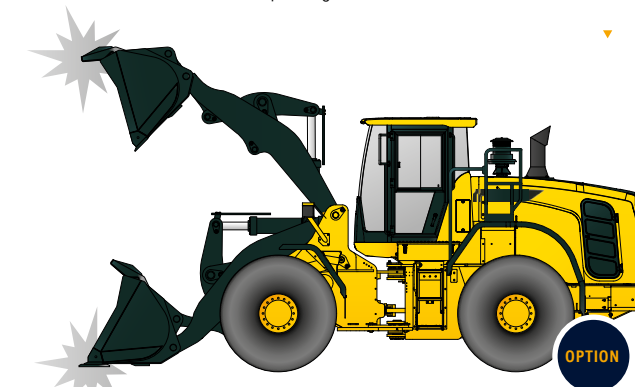

Instrument cluster

All the indicators displaying machine status are centralised in one cluster to enable easy, efficient control.



Safety

CREATING A SAFE WORKING ENVIRONMENT

Details can make a huge difference when it comes to safety, especially if you're working in rough conditions. It's not just a matter of complying with rules. The HL930A's safety features are designed and tested to meet your needs in the real world, even offering an extra pair of eyes with the optional Advanced Around View Monitoring (AAVM) and radar systems. By helping to ensure a calm, accident-free worksite, this wheel loader adds to the productivity and peace of mind that are all part of the HD Hyundai Effect.



"The camera and radar systems give me extra confidence and help me work more efficiently."



NEW

Emergency stop switch
The engine can be shut down immediately using an emergency stop switch located at the base of the seat.



OPTION

Advanced Around View Monitoring (AAVM) and Intelligent Moving Object Detection (IMOD)
The optional Advanced Around View Monitoring (AAVM) system gives you a 360° overview of your immediate working environment. It also includes Intelligent Moving Object Detection (IMOD) technology that senses and warns you when people or objects come within five metres of the machine.



NEW

Seat belt warning alarm
Operators are reminded to fasten their safety belt by an audible and visible alarm.

Radar system
The optional radar system detects obstacles behind the machine day and night, with no blind spots. The distance between the obstacle and the loader is displayed on the secondary monitor.

NEW

OPTION



NEW

Foldable side mirror
The side mirror is easy to adjust for optimal visibility and can be folded away to prevent damage during transportation.



Serviceability & Connectivity

ADVANCED DIAGNOSTICS AND SERVICING SUPPORT

The peace of mind that comes with quick, low-effort servicing is also part of the HD Hyundai Effect. The HL930A is designed to make maintenance as convenient as possible. All components and materials have been optimised to ensure a trouble-free life with minimal maintenance. HD Hyundai's innovative Hi MATE telematics system enables full monitoring of machine activity and performance. Maximum connectivity is integrated to help you create a smart construction site and protect your profitability.



“The new smart technologies make it easier to keep track of maintenance and get extra support if I need it.”



Auto greasing system
With the optional auto greasing system, grease is applied to lubrication points automatically when needed. The correct dosing is ensured and lubricant is applied uniformly, reducing grease consumption and eliminating waste.



Extended fuel filter lifetime
The fuel filter service interval has been increased from 500 hours to 1,000 hours.



Airco filters
The air conditioning uses a 2-stage filtration system allowing easy replacement of the filters.



Cooling system
The HL930A has dependable wide-core and fin coolers that prevent performance degradation caused by contamination. On top, it is equipped with a regulated, automatic/manual reversible fan.

NEW Low-maintenance DPF
DPF cleaning is only required if alerted by a fault indication, eliminating the need for regular ash cleaning intervals.

HiMATE

Boost efficiency and performance

For maximum convenience and security, the HL930A features HD Hyundai's exclusive Hi MATE remote fleet management system, which uses mobile data technology to provide the highest level of service and support. You can monitor your equipment wherever you are via a dedicated website or mobile app, with access to working parameters like total engine hours, machine utilisation, actual performed working hours, fuel consumption and machine location.

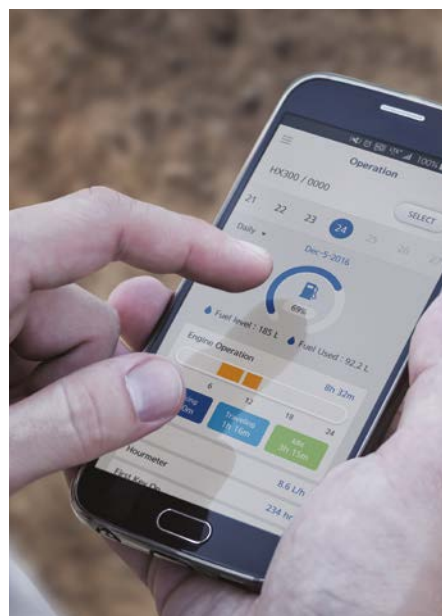

ECD (Engine Connected Diagnostics)
ECD provides troubleshooting advice as well as tailored servicing and parts support from Cummins Quick Serve. Service technicians are supported with remote diagnostics reports allowing them to prepare for site visits and bring the right tools.

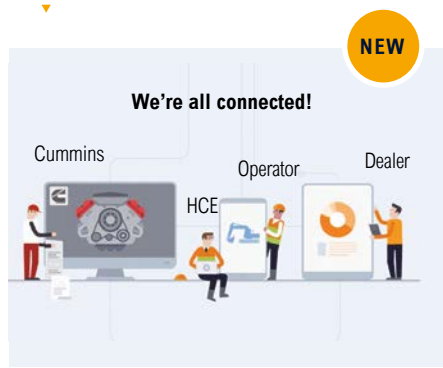

Increase productivity
By providing information such as service hours, idle time and fuel consumption, Hi MATE saves you money and improves productivity. Service alerts enable better maintenance planning.

Monitor your machines
Hi MATE's real-time location information allows better, more convenient monitoring of your equipment. Just log onto the Hi MATE website or mobile app to see your machines at any time, from any location. Receive data online, by e-mail or directly on your mobile device.

Improve security
Protect your equipment from theft or unauthorised usage. Hi MATE's geofencing alerts notify you automatically when a machine leaves a predetermined zone.

Parts & Warranties

HD HYUNDAI GENUINE PARTS AND WARRANTIES: THE BEST WAY TO PROTECT YOUR INVESTMENT

HD Hyundai Genuine parts, accessories and warranty programmes are specially designed to keep your machine covered. They increase uptime and maintain the performance, comfort, and convenience that are built into your equipment.



A network you can rely on

HD Hyundai Construction Equipment Europe prioritises quick, reliable intervention to keep your equipment running reliably. In the 13000 m² warehouse, HD Hyundai covers over 96% of all Genuine Parts. With one of Europe's most advanced automated warehousing systems, we are able to maintain availability and efficient delivery of all our Genuine Parts. Moreover, we guarantee a 24-hour delivery service across our European dealer network.



Fuel filters

HD Hyundai fuel filters provide the right degree of filtration to keep your engine clean. They are designed to meet and exceed the engine manufacturer's prerequisites for water separation and dirt filtration, prolonging the life of your engine.



HD Hyundai Genuine parts

HD Hyundai Genuine parts have the same design as those installed when your machine left the factory. They are subjected to rigorous quality inspections and tests to make sure they meet HD Hyundai's strict requirements for quality and durability. As well as minimising downtime, this helps to ensure peak performance on every task.



Aftermarket kits

You can order HD Hyundai aftermarket kits via your dealer. This AAVM system for example, improves safety in and around your working environment at all times.



HD Hyundai warranties

Our warranties are also designed to give you the cover you need to build your business with confidence and peace of mind.

Standard warranties

We offer standard warranty coverages for all wheel loaders. Next to this standard coverage, optional and extended warranty periods are available, so you can benefit from full warranty coverage for longer, and even over the full lifetime of the machines. Please discuss the optimal solution for your needs with your local HD Hyundai dealer.

Extended warranties

Our extended warranties help you maintain full control over your operating costs. If you combine an extended warranty programme with a tailored maintenance contract, you can completely avoid unexpected costs.

Walk-around

HL930A

Productivity & Efficiency

- EU Stage V engine **NEW**
- Eco Report **NEW**
- Smart Power mode **NEW** **OPTION**
- Hydraulic differential lock **OPTION**
- Intelligent Clutch Cut-off (ICCO)
- Automatic engine shutdown
- Optimised power matching
- Accurate weighing system

Durability

- Optimised axles
- Sinter brake disc
- High grade hoses
- All-in-one aftertreatment system

Operator Comfort

- Spacious soundproofed cabin **NEW**
- Fully adjustable seat and armrest **NEW** **OPTION**
- Air compressor **NEW** **OPTION**
- Remote door control **NEW** **OPTION**
- Ride control system **OPTION**
- Wide touchscreen monitor
- Centralised instrument cluster
- Soft end stop **OPTION**



Serviceability

- Low-maintenance DPF **NEW**
- ECD (Engine Connected Diagnostics) **NEW**
- Hi-MATE telematic system
- Easy filter replacement
- Wide core & fin radiator
- Auto greasing system **OPTION**
- Longer-lasting fuel filter
- Reversible fan

Safety

- Emergency stop switch **NEW**
- Seat belt warning alarm **NEW**
- Radar rear detection **NEW** **OPTION**
- AAVM camera system **OPTION**
- IMOD (Intelligent Moving Object Detection) **OPTION**
- Foldable side mirror **NEW**

READY TO CHANGE YOUR WORLD

HD Hyundai's A-Series wheel loaders are designed to create better conditions for operators and deliver the ultimate ownership experience. Every detail is carefully fine-tuned to match your needs in the field, including better safety and comfort, higher productivity, maximum uptime and easy servicing. This is all part of the HD Hyundai Effect.

Explore the range at hyundai-ce.eu



SPECIFICATIONS

ENGINE	
Maker / Model	CUMMINS / B4.5 / EU Stage V
Type	4 cylinder, water cooled, 4-cycle, turbocharged, charge air cooled, direct injection, electronic controlled diesel engine
Aftertreatment technology	Wastegate turbocharger DOC/ DPF/ SCR
Gross Power (SAE J1995)	99 kW (133 hp) at 2,200 rpm
Net Power (SAE J1349)	97 kW (130 hp) at 2,200 rpm
Max. Power	99 kW (133 hp) at 2,200 rpm
Peak Gross Torque (SAE J1995)	633 NM (467 lb ft) at 1,200 rpm
Displacement	4.5 l (275 cu in)

TRANSMISSION	
Torque Converter Type	3-Elements, Single-stage, Single phase
Tyre	17.5 R25, **, L3

Travel Speed, km/h (mph)		
		4 speed T/M
Forward	1st	6.6 (4.1)
	2nd	12.1 (7.5)
	3rd	23.6 (14.7)
	4th	39.5 (24.5)
Reverse	1st	7.0 (4.3)
	2nd	12.7 (7.9)
	3rd	24.8 (15.4)

AXLES	
Drive System	Four-wheel drive system
Mount	Rigid front axle and oscillating rear axle
Rear Axle Oscillation	Oscillating ±11° degrees
Hub Reduction	Planetary reduction at wheel end
Differential	LS front/ rear open
Reduction Ratio	20.365

TYRES	
Type	Tubeless, loader design tyres
Standard	17.5 R25, **, L3
Option	17.5 R25, *, XHA

HYDRAULIC SYSTEM		
Type	Load sensing hydraulic system	
Pump	Variable displacement piston pump, 132 lpm	
Control valve	2 Spool (Bucket, Boom), standard 3 Spool (Bucket, Boom, Aux), optional	
System pressure	250 bar (3,626 psi)	
Lift Circuit	The valve has four functions: Raise / Hold / Lower / Float. Adjustable automatic kickout lifting and lowering position.	
Tilt Circuit	The valve has three functions: Tilt back / Hold / Dump. Adjustable automatic bucket positioner to desired load angle.	
Cylinder	Type: double acting	
	No. of cylinders-bore × stroke	
	Lift	2-100 x 750 mm 3.9" x 2' 6"
	HL930A Tilt	110 x 510 mm 4.3" x 1' 8"
HL930A XT Tilt	110 x 515 mm 4.3" x 1' 8"	
Cycle Time	Raise: 5.8 sec, Dump: 1.5 sec Lower: 3.6 sec, Total: 10.9 sec	

* HD Hyundai Bio Hydraulic Oil (HBHO) available

STEERING SYSTEM	
Type	Load sensing hydrostatic articulated steering
Pump	Variable displacement piston pump, 132 lpm
Relief Valve Setting	210 bar (3,046 psi)
Cylinder	Double acting
	2-60 x 412 mm 2.4" x 1' 4"
Steering Angle	40° to both right and left angle, respectively
Features	Center-point frame articulation. Tilt and telescopic steering column.

BRAKES	
Service Brakes	Hydraulically actuated, wet disc brakes actuate all 4 wheels independent axle-by-axle system. Self adjusting & wheel speed brake.
Parking Brake	Spring-applied, hydraulically released brake
Emergency Brake	When brake oil pressure drops, indicator light alerts operator and parking brake automatically applies.

CABIN	
ROPS / FOPS Cabin Meet ISO 3471 and ISO 3449	

SOUND	
Guaranteed noise level presented below can be differed depending on a range of factors such as operating condition, speed of a cooling fan, types of engine and so forth. Hearing protection shall be necessary if an operator is working in the improperly maintained cabin or exposed to a noisy environment by leaving doors and/or windows open.	
With Cooling Fan Speed at Maximum Value:	
Operator sound pressure level (ISO 6396:2008)	70 dB(A)
Exterior sound power level (ISO 6395:2008)	102 dB(A)

* Distance of 15 m (49.2 ft), moving forward in second gear ratio.

AIR CONDITIONING SYSTEM	
The air conditioning system of this machine contains fluorinated greenhouse gas refrigerant R134a (GWP = 1430). The system contains 0.75 kg of refrigerant (1.07 metric tonne CO ₂ equivalent).	

OVERVIEW				
Description	Unit	HL930A	HL930A XT	
Operating weight	kg	11,500	11,700	
	lb	25,355	25,795	
Bucket capacity	Heaped	m ³	1.90	1.90
		yd ³	2.50	2.50
	Struck	m ³	1.60	1.60
		yd ³	2.10	2.10
Breakout force-bucket	kg	9,150	9,070	
	lb	20,175	20,000	
Tipping load	Straight	kg	9,100	8,200
		lb	20,065	18,080
	Full turn	kg	8,000	7,100
		lb	17,640	15,655

SERVICE REFILL CAPACITIES		
UNIT	l	US gal
Fuel tank	189.5	50
DEF tank	19.0	5.0
Cooling system	31.5	8.3
Crankcase	11.0	2.9
Transmission	34.5	9.1
Front axle	23.0	6.1
Rear axle	23.0	6.1
Hydraulic tank	90.0	23.8
Hydraulic system (including tank)	130.0	34.3

DIMENSIONS & SPECIFICATIONS

DIMENSIONS

All dimensions are approximate.

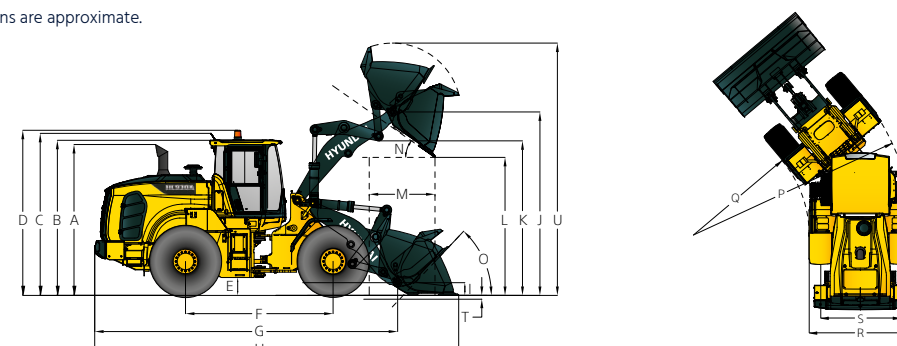

Description	HL930A		HL930A XT	
	mm	ft-in	mm	ft-in
A Height to Top of Exhaust Pipe	2,945	9' 8"	2,945	9' 8"
B Height to Top of Cabin	3,170	10' 5"	3,170	10' 5"
C Height to Top of Product Link Antenna	3,235	10' 7"	3,235	10' 7"
D Height to Top of Warning Beacon	3,300	10' 10"	3,300	10' 10"
E Ground Clearance	370	1' 3"	370	1' 3"
F Wheelbase	2,900	9' 6"	2,900	9' 6"
G Overall Length (Without Bucket)	6,090	19' 12"	6,380	20' 11"
H Shipping Length (With Bucket Level on Ground)	7,125	23' 5"	7,415	24' 4"
I Hinge Pin Height at Carry Position	405	1' 4"	495	1' 7"
J Hinge Pin Height at Maximum Lift	3,640	11' 11"	3,980	13' 1"
K Lift Arm Clearance at Maximum Lift	3,125	10' 3"	3,465	11' 4"
L Dump Clearance at Maximum Lift and 45° Discharge	2,700	8' 10"	3,035	9' 11"
M Reach at Maximum Lift and 45° Discharge	1,065	3' 6"	1,035	3' 5"
N Dump Angle at Maximum Lift and Dump (on Stops)	48	-	48	-
O Roll Back Angle	Ground	42	42	-
	Carry	47	48	-
P Clearance Circle (Diameter) to Outside of Tyres	10,555	34' 8"	10,555	34' 8"
Q Clearance Circle (Diameter) to Inside of Tyres	5,710	18' 9"	5,710	18' 9"
R Width Over Tyres (Unloaded)	2,375	7' 10"	2,375	7' 10"
S Tread Width	1,930	6' 4"	1,930	6' 4"

OPERATING SPECIFICATIONS WITH BUCKETS

Linkage	Standard Linkage			High Lift Linkage
	General Purpose - Pin On		General Purpose - Hook On	
Bucket Type	Bolt-On Cutting Edges		Bolt-On Cutting Edges	
Edge Type	1 Piece Tooth			
Capacity - Rated	m ³	1.90	1.90	-
	yd ³	2.50	2.40	-
Capacity - Rated at 110% Fill Factor	m ³	2.10	2.00	-
	yd ³	2.70	2.60	-
Width	mm	2,450	2,480	-
	ft/in	8' 0"	8' 2"	-
Dump Clearance at Maximum Lift and 45° Discharge	mm	2,700	2,620	+335
	ft/in	8' 10"	8' 7"	+1' 1"
Reach at Maximum Lift and 45° Discharge	mm	1,065	1,145	-30
	ft/in	3' 6"	3' 9"	-1.2"
Digging Depth	mm	105	115	+15
	ft/in	0' 4"	0' 5"	+0.6"
T Shipping Length (with Bucket)	mm	7,125	7,240	+290
	ft/in	23' 5"	23' 9"	+11.4"
U Overall Height with Bucket at Maximum Lift	mm	4,855	4,855	+340
	ft/in	15' 11"	15' 11"	+1' 1"
V Loader Clearance Circle	mm	11,660	11,780	+280
		38' 3"	38' 7"	+11"
Static Tipping Load, Straight (No Tyre Deflection)	kg	9,100	9,270	-900
	lb	20,065	20,440	-1,980
Static Tipping Load, Articulated (No Tyre Deflection)	kg	8,000	8,150	-900
	lb	17,640	17,970	-1,980
Breakout Force	kg	9,150	9,770	-80
	lb	20,175	21,540	-175
Operating Weight*	kg	11,500	11,420	+200
	lb	25,355	25,180	+445

* All height and tyre related dimensions are with standard 17.5 R25, **, L3 tyres

DENSITY AND BUCKET SELECTION

DENSITY OF OPERATING MATERIALS		
Loose Material	Material Density [ton / m ³]	Possible Bucket Fill [%]
Earth / Clay	1.5 ~ 1.7	~110
Sand and Gravel	1.5 ~ 1.7	~105
Aggregate	25 ~ 76 mm (1" to 3 in)	~100
	19 mm (0.75 in) and larger	

HL930A BUCKET SELECTION CHART																	
Standard Lift Arm - General Purpose Bucket																	
Type	m ³	Material Density															
		1.0	1.1	1.2	1.3	1.4	1.5	1.6	1.7	1.8	1.9	2.0	2.1	2.2	2.3	2.4	2.5
Cutting edge	1.9	2.2 m ³											1.8 m ³				
1 pc Bolt on tooth	1.8	2.1 m ³											1.7 m ³				
2 pc Bolt on tooth	1.9	2.2 m ³											1.8 m ³				
High Lift Arm - General Purpose Bucket																	
Type	m ³	Material Density															
		1.0	1.1	1.2	1.3	1.4	1.5	1.6	1.7	1.8	1.9	2.0	2.1	2.2	2.3	2.4	2.5
Cutting edge	1.9	2.2 m ³											1.8 m ³				
1 pc Bolt on tooth	1.8	2.1 m ³											1.7 m ³				
2 pc Bolt on tooth	1.9	2.2 m ³											1.8 m ³				

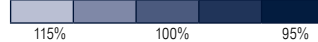
Fill Factor 

115% 100% 95%

CHANGE IN OPERATING SPECIFICATIONS - TYRES		
Tyres		17.5 R25, ★, XHA
Operating Weight	kg	-30
	lb	-65
Static Tipping Load. Straight (No Tyre Deflection)	kg	-40
	lb	-85
Static Tipping Load. Articulated (No Tyre Deflection)	kg	-35
	lb	-75
Vertical Height Changes	mm	-4
	ft/in	-0.2"
R Width Over Tyres (Unloaded)	mm	3
	ft/in	0.1"
P Clearance Circle (Diameter) to Outside of Tyres	mm	3
	ft/in	0.1"
Q Clearance Circle (Diameter) to Inside of Tyres	mm	-3
	ft/in	-0.1"

** Dimension changes compared to 17.5 R25, ★★, L3 radial tyres.

STANDARD/OPTIONAL EQUIPMENT

CABIN & INTERIOR	STD
ALARMS, AUDIBLE AND VISUAL	
Central warning lamp	•
Air filter clogging	•
Battery voltage	•
Brake oil pressure	•
DEF low level	•
Engine coolant level	•
Engine oil pressure	•
Fuel level	•
Hydraulic oil temperature	•
Engine coolant temperature	•
Parking brake	•
Service brake oil pressure	•
Seat belt ON/OFF	•
Transmission error	•
Transmission oil temperature	•
INDICATOR LIGHTS	
Parking brake	•
High beam	•
FNR	•
Differential Lock	•
Pilot cut off	•
Turning light	•
Seat belt ON/OFF	•
Engine auto stop	•
Clutch Cut Off	•
Ride control	•
LCD DISPLAY	
DEF level	•
DEF low level	•
Transmission gear range	•
Clock and fault code	•
Job time and distance	•
Operating hour counter	•
Engine rpm	•
GAUGES	
Diesel Exhaust Fluid (DEF) level	•
Engine coolant temperature	•
Fuel level	•
Speedometer	•
Transmission oil temperature	•
BATTERIES	
850CCA, 12V, 2PCS	•
LIGHTING SYSTEM	
LED interior cabin light	•
2 stop and tail lights	•
2 Stop and tail lights (LED)	•
4 turn signals	•
2 Head lights on front frame	•
2 Head lights (LED) on front frame	•
2 Working lights on front cabin roof	•
4 Working lights on front cabin roof	•
2 Working lights on rear cabin roof	•
4 Working lights (LED) on front cabin roof	•
2 Working lights (LED) on rear cabin roof	•
2 Working lights on rear grill	•
2 Working lights (LED) on rear grill	•
IGNITION	
Standard Key	•
Smart key with start/stop button	•
SWITCHES	
Battery master switch	•
Differential Lock	•
Transmission oil sight level	•
FNR shifter	•
Hazard	•
Parking brake	•
Pilot cut off	•
DPF	•
Emergency steering	•
Horn, electric	•
MEMBRANE SWITCHES IN MONITOR	
Main light	•
Work light	•
Auto grease	•
Quick coupler	•
Ride control	•
Work load	•

CABIN & INTERIOR	STD
Beacon light	•
Rear wiper	•
Mirror heat	•
Auto position (boom/ bucket)	•
Fine modulation	•
Rear view camera activation	•
CABIN (SOUND SUPPRESSED)	
ROPS / FOPS Cabin	•
Coat hoot	•
Rear view mirrors (1 Inside)	•
Rear view mirrors (2 Outside, heated)	•
Steering column, tilt and telescopic	•
Steering wheel with knob	•
Roller type sunshade (Front window)	•
Roller type sunshade (Rear window)	•
Tinted safety glass	•
1 cabin door (LH)	•
Magazine pocket	•
Radio / USB player with Bluetooth	•
Rubber floor mat	•
Wrist rest	•
24V to 12V DC converter (20A)	•
DOOR	
Door and cabin locks, standard key	•
Doors, service access (Locking)	•
Remote cabin door opener system	•
AUTOMATIC CLIMATE CONTROL	
Air conditioner & heater	•
Defroster	•
Intermittent wiper and washer, front and rear	•
SEAT	
Air suspended, heated seat	•
Mechanical suspended, heated seat	•
PERSONAL STORAGE SPACE	
Console box	•
Holder, can and cup	•
PEDALS	
Single brake pedal	•
Dual-brake pedal	•
Accel pedal without ECO switch	•
Accel pedal with ECO switch	•
ENGINE	
Alternator, 95A	•
Antifreeze	•
Fuel warmer	•
Fan guard	•
Rain cap, Engine air intake	•
Coolant Level Sight Gauge	•
Centrifugal air pre-cleaner	•
ENGINE, CUMMINS, B4.5	
EU STAGE V / EPA TIER 4 FINAL	•
Fuel / water separator	•
Engine oil level dipstick gauge	•
CLEAN EMISSION MODULE	
DOC, DPF and SCR	•
POWER TRAIN	
TRANSMISSION	
Powershift Transmission F4/R3, computer controlled, electronic soft shift, auto-shift and kick-down features included	•
Transmission oil sight level	•
FRONT AXLE	
Limited Slip differential	•
Open differential	•
Hydraulic lock differential	•
REAR AXLE	
Open differential	•
Limited Slip differential	•
BRAKE	
Service brake (Enclosed wet-disc)	•
Parking brake	•
TYRES	
17.5 R25, ★★, L3	•
17.5 R25, ★, XHA	•

HYDRAULIC SYSTEM	STD
MCV 2 spools (boom/ bucket)	•
MCV 3 spools (boom/ bucket/ aux)	•
Boom positioning system (automatic)	•
Bucket positioning system (automatic)	•
Diagnostic pressure taps	•
HYDRAULIC CONTROL	
Joystick	•
Fingertip	•
ELECTRO-HYDRAULIC CONTROL	
Joystick	•
Fingertip	•
Extra piping for auxiliary function	•
Quick coupler piping	•
Ride control system	•
HD Hyundai Bio Hydraulic Oil (HBHO)	•
Hydraulic oil level sight gauge	•
SAFETY	
Emergency stop	•
Alarm, back-up	•
Boom safety bar	•
Emergency steering	•
Wheel Chocks	•
OBJECT DETECTION	
Rear view camera	•
IMOD (Intelligent Moving Object Detection)	•
AAVM (Advanced Around View Monitoring)	•
Secondary Monitor	•
Radar	•
TELEMATICS	
Hi MATE	•
ECN (Engine Connected Diagnostics)	•
OTHER	
Auto Greasing	•
Articulation locking bar	•
Air compressor	•
Tool kit	•
Lift and tie-down hooks	•
Loader linkage, sealed	•
Z-kinematic	•
Extended Boom (Highlift)	•
ISO type quick coupler	•
Vandalism protection cap locks	•
BUCKET	
1.9 m ³ Bolt-on Cutting Edge type	•
1.8 m ³ 1-Piece Tooth type	•
1.9 m ³ Bolt-on Cutting Edge ISO type Q/C	•
COUNTERWEIGHT	
Counterweight	•
Counterweight - Heavy weight	•
Drawbar with pin	•
ACCESS	
Handrails (LH/ RH) ergonomically located	•
Ladders (LH/ RH) slip resistant	•
Platforms (LH/ RH) slip resistant	•
Steps ergonomically located, slip resistant	•
GUARDS	
Transmission	•
Fenders (Front / Rear)	•
Mud guards	•

* Standard and optional equipment may vary. Contact your HD Hyundai dealer for more information. The machine may vary according to International standards.

* The photos may include attachments and optional equipment that are not available in your area.

* Materials and specifications are subject to change without advance notice.

* All imperial measurements rounded off to the nearest pound or inch.

HYUNDAI



HD Hyundai Construction Equipment Europe nv, Hyundailaan 4,
3980 Tessenderlo, Belgium. Tel: (32) 14-56-2200 Fax: (32) 14-59-3405

Specifications and design are subject to change without notice. Pictures of HD Hyundai Construction Equipment Europe products may show other than standard equipment.

READY TO CHANGE YOUR WORLD?

Contact your HD Hyundai dealer.
hyundai-ce.eu/en/dealer-locator